

Plastic Fans

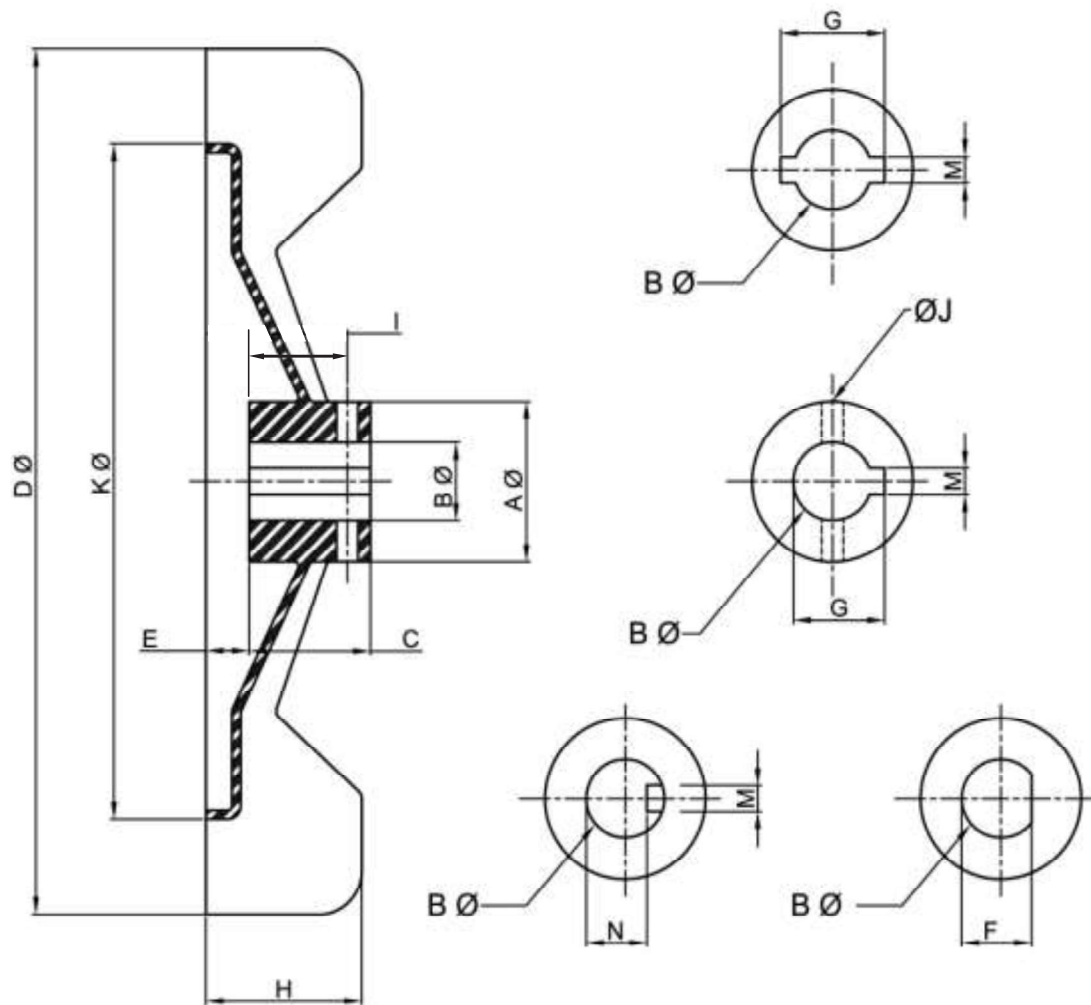

REFERENCE ABBREVIATIONS

A	BOSS DIAMETER	K	DIAMETER WITHOUT FINS
B	BORE DIAMETER	M	WIDTH OF KEY WAY SLOT
C	BORE LENGTH	B1	ALTERNATE BORE SIZE
D	OUT SIDE DIAMETER	I	DISTANCE OF COTTER PIN FROM FACE OF BOSS
E	DISTANCE FROM THE FACE OF THE FAN TO THE BOSS	F	DISTANCE OF FLATTEND BORE
H	HEIGHT OF THE FAN BLADES	G	DISTANCE BETWEEN KEYWAYS / BORE TO KEYWAY
J	COTTER PIN HOLE DIAMETER/ TAPPED HOLE	N	DISTANCE BETWEEN KEYWAY SLOT TO BORE

NOTE:

- ALL DIMENSIONS ARE IN MM.
- PHOTOGRAPHS NOT TO SCALE.
- WE RESERVE THE RIGHT TO CHANGE AND MODIFY SPECIFICATIONS WITHOUT PRIOR NOTICE.
- ITEMS MISSING IN THE SERIAL ORDER HAVE BEEN DISCONTINUED.

Plastic Fans

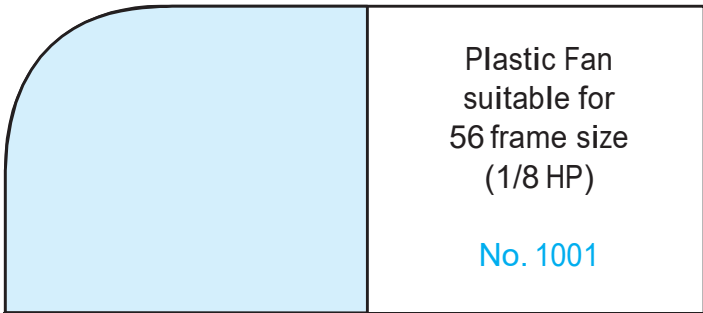

Plastic Fan
suitable for
56 frame size
(1/8 HP)

No. 1001

DRG. NO.	AØ	BØ	B1	C	DØ	E	H	I	JØ	NO OF BLADES	KØ
56-01-001	19	8	9, 11	14	100	5	18	10	3	10	79

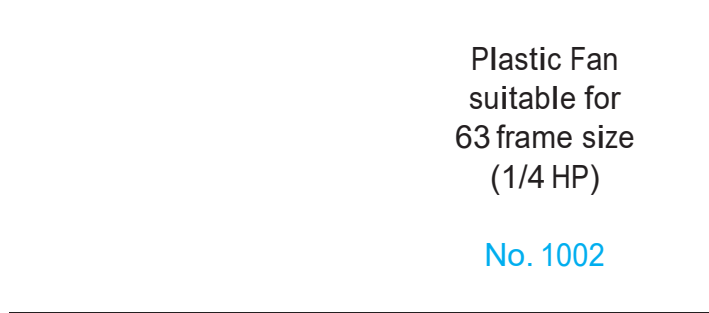

Plastic Fan
suitable for
63 frame size
(1/4 HP)

No. 1002

DRG. NO.	AØ	BØ	B1	C	DØ	E	H	I	JØ	NO OF BLADES	KØ
63-01-002	23	9	12, 14	12	111	8	19	9	3	12	88

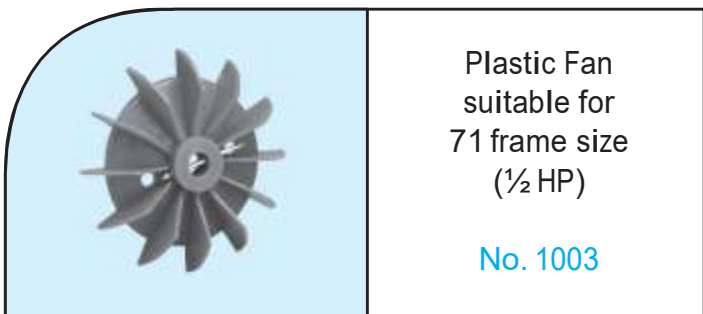

Plastic Fan
suitable for
71 frame size
(1/2 HP)

No. 1003

DRG. NO.	AØ	BØ	B1	C	DØ	E	H	I	JØ	NO OF BLADES	KØ
71-01-003	30	9	12,14, 15,16,19	17	128	5	30.5	12	3	12	97

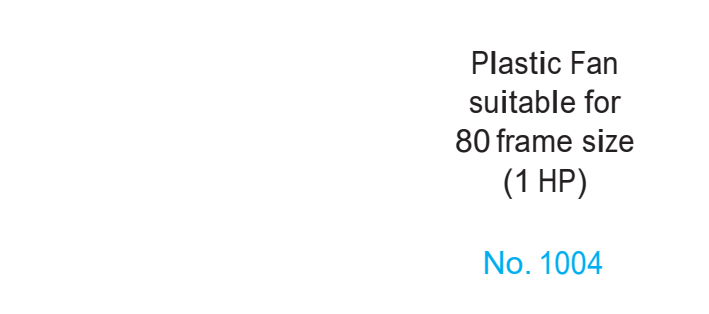

Plastic Fan
suitable for
80 frame size
(1 HP)

No. 1004

DRG. NO.	AØ	BØ	B1	C	DØ	E	H	I	JØ	NO OF BLADES	KØ
80-01-004	35	15	16,19, 5/8",24	20	146	5	28	13	4	8	118

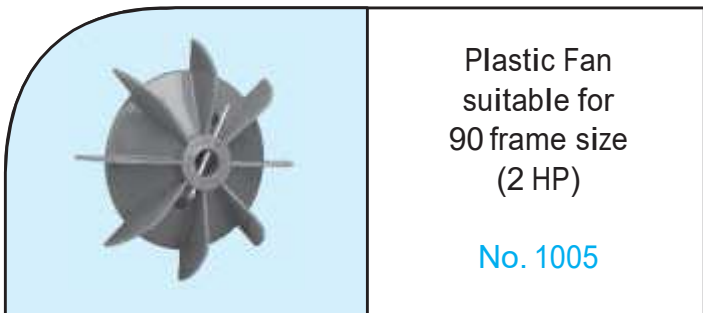

Plastic Fan
suitable for
90 frame size
(2 HP)

No. 1005

DRG. NO.	AØ	BØ	B1	C	DØ	E	H	I	JØ	NO OF BLADES	KØ
90-01-005	37	16	17,19, 22	19	165	11	37	14	4	8	122

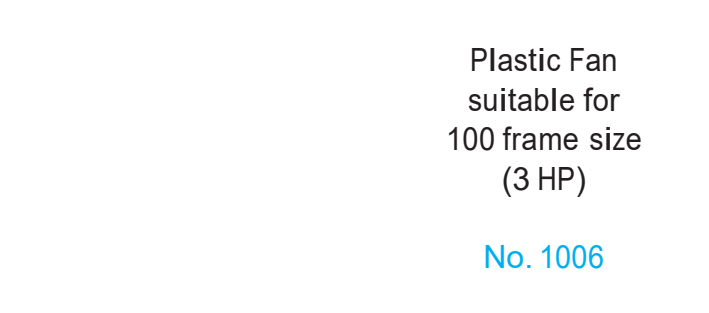

Plastic Fan
suitable for
100 frame size
(3 HP)

No. 1006

DRG. NO.	AØ	BØ	B1	C	DØ	E	H	I	JØ	NO OF BLADES	KØ
100-01-006	44	16	19,20,22, 25,26,28	25	179	9	41	19	4	8	135

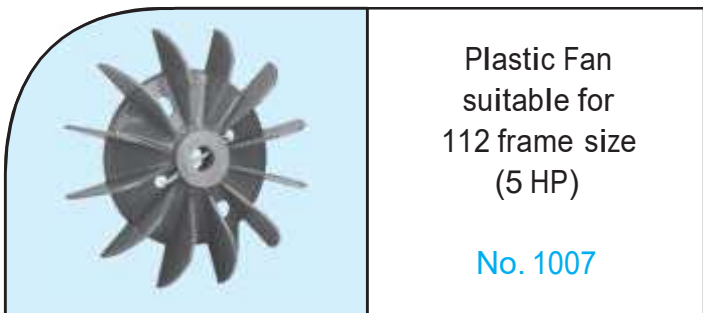

Plastic Fan
suitable for
112 frame size
(5 HP)

No. 1007

DRG. NO.	AØ	BØ	B1	C	DØ	E	H	I	JØ	NO OF BLADES	KØ
112-01-007	44	19	20,22,24, 25,26,28	25	210	8	47	19	4	12	140

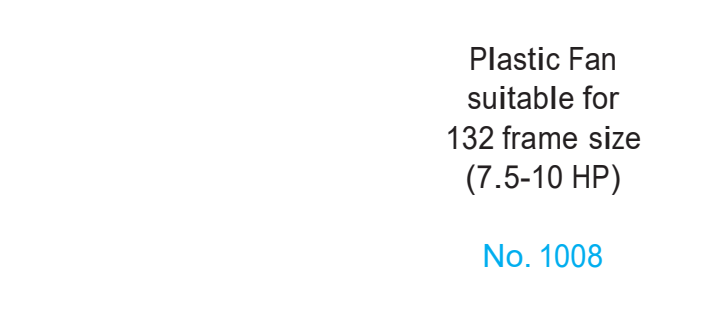

Plastic Fan
suitable for
132 frame size
(7.5-10 HP)

No. 1008

DRG. NO.	AØ	BØ	B1	C	DØ	E	H	I	JØ	NO OF BLADES	KØ
132-01-008	44	25	26,28,30	24	244	8	46	18	4	12	166

Plastic Fans

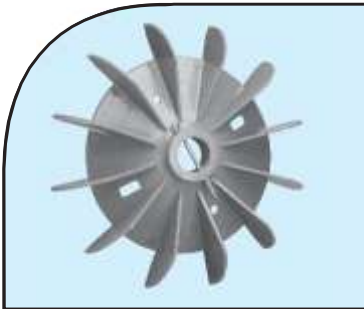

Plastic Fan suitable for 160 frame size (15-20 HP)

No. 1009

DRG. NO.	AØ	BØ	B1	C	DØ	E	H	I	JØ	NO OF BLADES	KØ
160-01-009	57	38	28,30	30	296	22	70	24	5	12	216

Plastic Fan suitable for 180 frame size (30-40 HP)

No. 1010

DRG. NO.	AØ	BØ	B1	C	DØ	E	H	I	JØ	NO OF BLADES	KØ
180-01-010	60	45	50	36	336	18	61	26	5	10	279

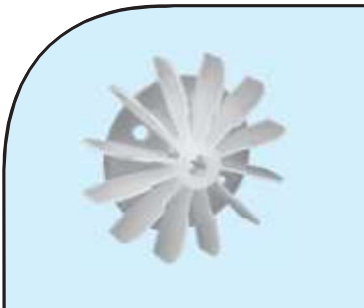

Plastic Fan suitable for P-80 frame size (1 HP)

No. 1011

DRG. NO.	AØ	BØ	B1	C	DØ	E	H	I	JØ	NO OF BLADES	KØ
80-02-011	29	15	16,19	24	140	9	35	16.5	3	12	107

Plastic Fan suitable for P-90 frame size (2 HP)

No. 1012

DRG. NO.	AØ	BØ	B1	C	DØ	E	H	I	JØ	NO OF BLADES	KØ
90-02-012	32	16	19, 22	28	150	9	40	19	3	12	106

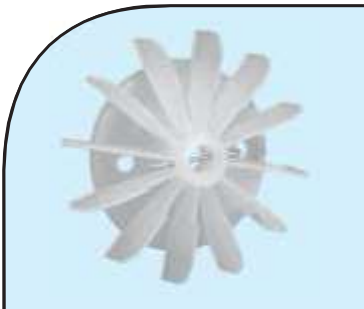

Plastic Fan suitable for P-100 frame size (3 HP)

No. 1013

DRG. NO.	AØ	BØ	B1	C	DØ	E	H	I	JØ	NO OF BLADES	KØ
100-02-013	38	16	19, 22, 25, 28	25	180	15	40	15	4	12	140

Plastic Fan suitable for P-112 frame size (5 HP)

No. 1014

DRG. NO.	AØ	BØ	B1	C	DØ	E	H	I	JØ	NO OF BLADES	KØ
112-02-014	38	19	18, 22, 25, 28	25	190	16	42	15	4	12	150

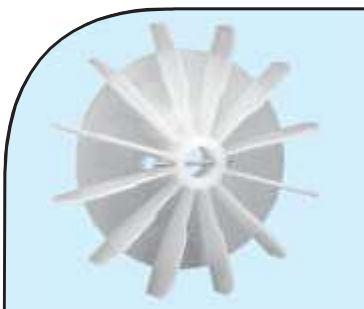

Plastic Fan suitable for P-132 frame size (7.5-10 HP)

No. 1015

DRG. NO.	AØ	BØ	B1	C	DØ	E	H	I	JØ	NO OF BLADES	KØ
132-02-015	42	25	28, 29, 30, 33	30	225	10.5	47	23	4	12	180

Plastic Fan suitable for Kirloskar N-90 frame size (2 HP) (Old Type)

No. 1016

DRG. NO.	AØ	BØ	B1	C	DØ	E	H	I	JØ	NO OF BLADES	KØ
90-03-016	29	18	16	16	156	4	29	10.5	4	10	125

Plastic Fans

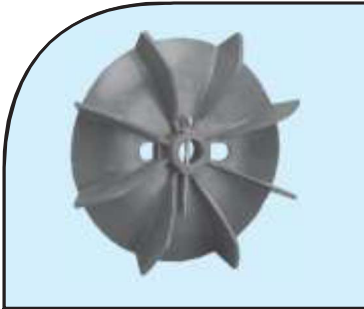

Plastic Fan
suitable for Kirloskar
N-100 frame size
(3 HP) (Old Type)

No. 1017

DRG. NO.	AØ	BØ	B1	C	DØ	E	H	I	JØ	NO OF BLADES	KØ
100-03-017	27.5	18	-	18	179	4.5	44	13	4	8	156

Plastic Fan
suitable for Kirloskar
N-112 frame size
(5 HP) (Old Type)

No. 1018

DRG. NO.	AØ	BØ	B1	C	DØ	E	H	I	JØ	NO OF BLADES	KØ
112-03-018	37	28	-	25	200	4	48	18	4	8	163



Plastic Fan
suitable for
Kirloskar KH-90
frame size (2 HP)

No. 1019

DRG. NO.	AØ	BØ	B1	C	DØ	E	H	I	JØ	NO OF BLADES	KØ
90-04-019	33.5	24	18	19.5	161	2	32	12	5	8	140

Plastic Fan
suitable for
Kirloskar KH-100
frame size (3 HP)

No. 1020

DRG. NO.	AØ	BØ	B1	C	DØ	E	H	I	JØ	NO OF BLADES	KØ
100-04-020	39	28	18	24	175	9	39	15	5	8	152



Plastic Fan
suitable for
Kirloskar KH-112
frame size (5 HP)

No. 1021

DRG. NO.	AØ	BØ	B1	C	DØ	E	H	I	JØ	NO OF BLADES	KØ
112-04-021	39	28	18	24	200	5	42.5	15	5	8	180

Plastic Fan
suitable for
Kirloskar KH-132 frame
size (7.5-10 HP)

No. 1022

DRG. NO.	AØ	BØ	B1	C	DØ	E	H	I	JØ	NO OF BLADES	KØ
132-03-022	48	38	32,35	30	241	8	47	20	6	8	206

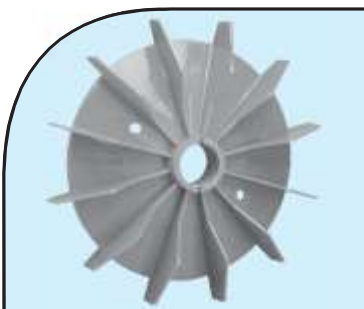

Plastic Fan
suitable for Kirloskar
KH-160 frame size
(15-20 HP)

No. 1023

DRG. NO.	AØ	BØ	B1	C	DØ	E	H	I	JØ	NO OF BLADES	KØ
160-02-023	54	42	38,40	34	289	12	61	23	7	12	241

Plastic Fan
suitable for
Siemens/Bharat Bijlee
71 frame size (1/4 HP)

No. 1024

DRG. NO.	AØ	BØ	B1	C	DØ	E	H	I	JØ	NO OF BLADES	KØ
71-02-024	21	15	14	15	127	4	21	12	3	12	96

Plastic Fans

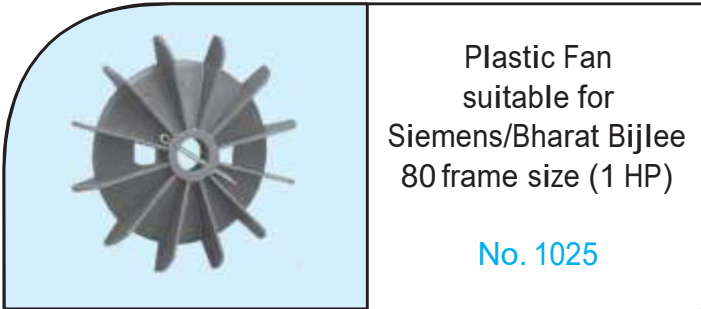

Plastic Fan
suitable for
Siemens/Bharat Bijlee
80 frame size (1 HP)

No. 1025

DRG. NO.	AØ	BØ	B1	C	DØ	E	H	I	JØ	NO OF BLADES	KØ
80-03-025	29	19	15	15.5	137	4.5	25	12	3	12	105

Plastic Fan
suitable for
Bharat Bijlee
90 frame size (2 HP)

No. 1026

DRG. NO.	A	B	B1	C	D	E	H	G	M	NO OF BLADES	KØ
90-05-026	38	24.5	-	19.5	150	20	37	34	7.8	7	125

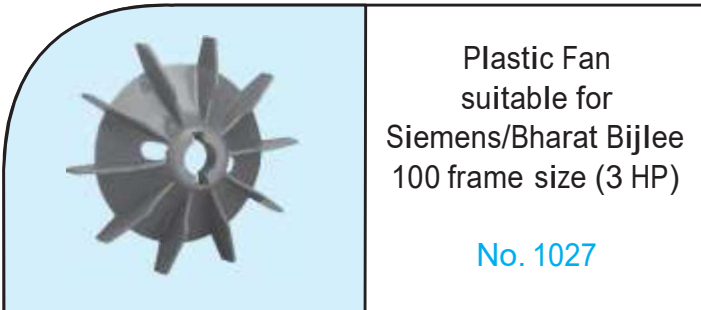

Plastic Fan
suitable for
Siemens/Bharat Bijlee
100 frame size (3 HP)

No. 1027

DRG. NO.	AØ	BØ	B1	C	DØ	E	H	G	M	NO OF BLADES	KØ
100-05-027	47	24	28	17.5	171	20	38	37	8	10	129

Plastic Fan
suitable for
Bharat Bijlee
100 frame size (3 HP)

No. 1027-B

DRG. NO.	A	B	B1	C	D	E	H	G	M	NO OF BLADES	KØ
100-05-027	45	29.5	-	17.5	171	21	39	39	7.8	10	131

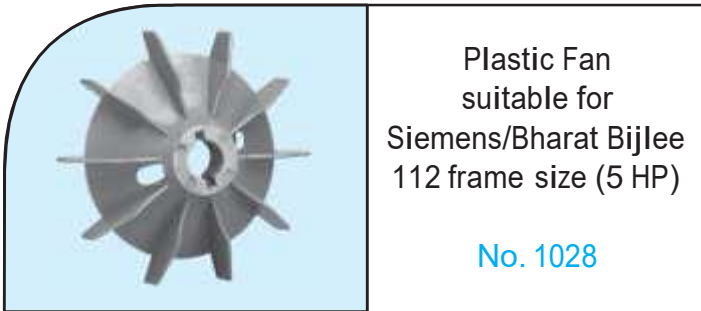

Plastic Fan
suitable for
Siemens/Bharat Bijlee
112 frame size (5 HP)

No. 1028

DRG. NO.	AØ	BØ	B1	C	DØ	E	H	G	M	NO OF BLADES	KØ
112-05-028	52	28	-	25	196	21	42	40	7	10	154

Plastic Fan
suitable for
Bharat Bijlee
112 frame size (5 HP)

No. 1028-A

DRG. NO.	A	B	B1	C	D	E	H	G	M	NO OF BLADES	KØ
112-05-028	55	29.5	-	25	197	20	44.5	39	7.8	10	151



Plastic Fan
suitable for Bharat
Bijlee 132 frame size
(7.5-10 HP)

No. 1029

DRG. NO.	AØ	BØ	B1	C	DØ	E	H	G	M	NO OF BLADES	KØ
132-04-029	60	40	-	27	235	28	53.5	49	7.8	10	186.5

Plastic Fan
suitable for Bharat
Bijlee 160 frame size
(15-20 HP)

No. 1030

DRG. NO.	AØ	BØ	B1	C	DØ	E	H	G	M	NO OF BLADES	KØ
160-03-030	60	45	-	35	285	30	63.5	54	7.8	10	221.5

Plastic Fans

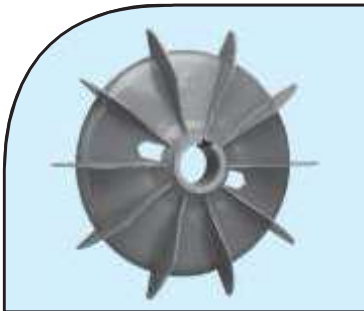

Plastic Fan
suitable for Siemens
160 frame size
(15-20 HP) (New Type)

No. 1031

DRG. NO.	AØ	BØ	B1	C	DØ	E	H	G	M	NO OF BLADES	KØ
160-04-031	54	42	44	40.5	276	1	51.5	46	12	10	225

Plastic Fan
suitable for
Siemens 180 frame size
(30-40 HP)

No. 1032

DRG. NO.	AØ	BØ	B1	C	DØ	E	H	G	M	NO OF BLADES	KØ
180-02-032	67	48	-	51	310	3	60	53	14	10	257

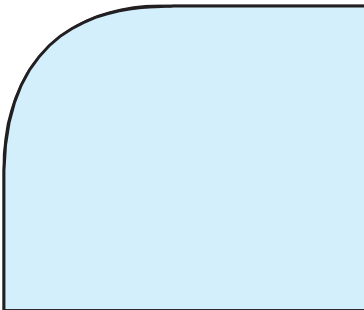

Plastic Fan
suitable for
Crompton Rotor Fan
(Inner Fan)

No. 1033

DRG. NO.	AØ	BØ	B1	C	DØ	E	H	I	JØ	NO OF BLADES	KØ
RF-01-033	29	17	18, 19, 22,	17	135	35.5	15	8	2 BA	12	116

Plastic Fan
suitable for
Crompton B-50 TF
(Outer Fan)

No. 1034

DRG. NO.	AØ	BØ	B1	C	DØ	E	H	I	JØ	NO OF BLADES	KØ
90-06-034	28	16	-	19	160	9.5	28	13	2 BA	10	126

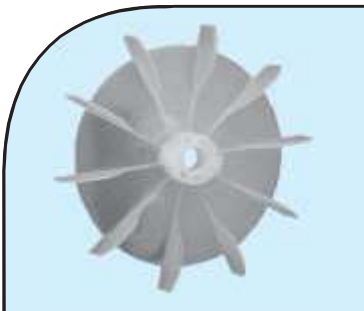

Plastic Fan
suitable for
Crompton 100 S

No. 1035

DRG. NO.	AØ	BØ	B1	C	DØ	E	H	I	JØ	NO OF BLADES	KØ
100-06-035	34	16	19	20	182	10	32	12	2 BA	10	152

Plastic Fan
suitable for
Crompton ND-80
frame size (1 HP)

No. 1036

DRG. NO.	AØ	BØ	B1	C	DØ	E	H	I	JØ	NO OF BLADES	KØ
80-04-036	25	19	15,16	20.5	135	2	23	13	4	10	130

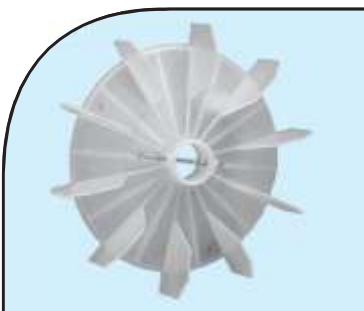

Plastic Fan
suitable for
Crompton ND-90
frame size (2 HP)

No. 1037

DRG. NO.	AØ	BØ	B1	C	DØ	E	H	I	JØ	NO OF BLADES	KØ
90-07-037	31	24	16, 19	18.5	155	4	30.5	10.5	4	10	127

Plastic Fan
suitable for
Crompton ND-100
frame size (3 HP)

No. 1038

DRG. NO.	AØ	BØ	B1	C	DØ	E	H	I	JØ	NO OF BLADES	KØ
100-07-038	35	28	16, 19, 24, 25	21	180	5.5	33	13	4	10	152

Plastic Fans

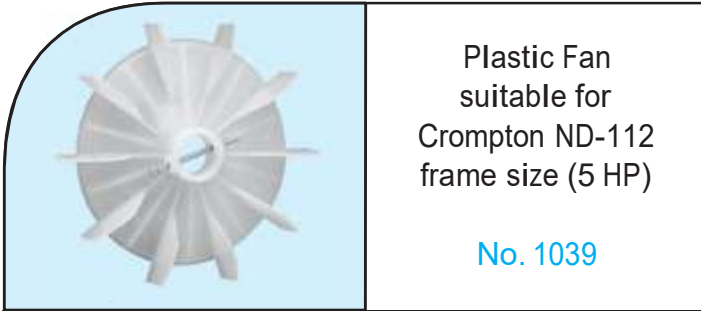

Plastic Fan
suitable for
Crompton ND-112
frame size (5 HP)

No. 1039

DRG. NO.	AØ	BØ	B1	C	DØ	E	H	I	JØ	NO OF BLADES	KØ
112-06-039	34	28	19,24, 25	24	201	6	43	14	4	10	170

Plastic Fan
suitable for Crompton
ND-132 frame size
(7.5-10 HP)

No. 1040

DRG. NO.	AØ	BØ	B1	C	DØ	E	H	I	JØ	NO OF BLADES	KØ
132-05-040	49	38	24,28, 30	25	239	19	53.5	13.5	5	10	208



Plastic Fan
suitable for
GEC 100 frame
size (3 HP)

No. 1041

DRG. NO.	AØ	BØ	B1	C	DØ	E	H	I	JØ	NO OF BLADES	KØ
100-08-041	40	28	25	23	181	8	40	19	4	10	141

Plastic Fan
suitable for
GEC 112 frame
size (5 HP)

No. 1042

DRG. NO.	AØ	BØ	B1	C	DØ	E	H	I	JØ	NO OF BLADES	KØ
112-07-042	39	28	-	24.5	207	4.5	41	22	4	10	163

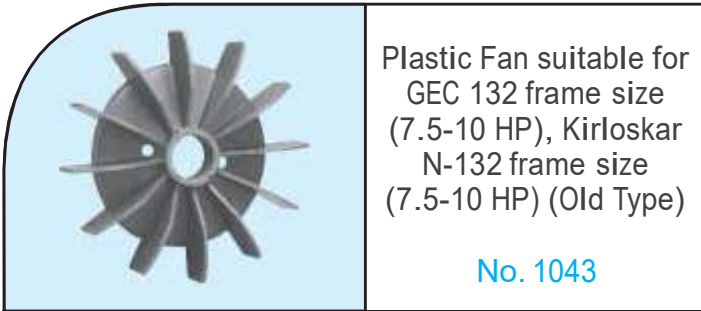

Plastic Fan suitable for
GEC 132 frame size
(7.5-10 HP), Kirloskar
N-132 frame size
(7.5-10 HP) (Old Type)

No. 1043

DRG. NO.	AØ	BØ	B1	C	DØ	E	H	I	JØ	NO OF BLADES	KØ
132-06-043	48	38	22	25	215	7.5	47	18.5	4	12	160

Plastic Fan suitable for
BBC 112 frame size
(3 HP) Saga Windel 112
frame size (5 HP) New
India 112 frame size (5 HP)

No. 1044

DRG. NO.	AØ	BØ	B1	C	DØ	E	H	I	JØ	NO OF BLADES	KØ
112-08-044	39	19	25,16	20	200	8	39	13.5	4	10	161



Plastic Fan
suitable for
BBC 132 frame
size (5 HP)

No. 1045

DRG. NO.	AØ	BØ	B1	C	DØ	E	H	I	JØ	NO OF BLADES	KØ
132-07-045	38	29	19	24.5	225	8.5	38	16	4	10	

Plastic Fan
suitable for
Jyoti 100 frame
size (3 HP)

No. 1046

DRG. NO.	AØ	BØ	B1	C	DØ	E	H	NO OF BLADES	KØ
100-09-046	34	20	-	23.5	169	6	36	14	144

Plastic Fans



Plastic Fan
suitable for
Jyoti 112 frame
size (5 HP)

No. 1047

DRG. NO.	AØ	BØ	B1	C	DØ	E	H	NO OF BLADES	KØ
112-09-047	39	22	-	19	197	9	36	14	145

Plastic Fan
suitable for
Jyoti 132
frame size (7.5-10 HP)

No. 1048

DRG. NO.	AØ	BØ	B1	C	DØ	E	H	G	M	NO OF BLADES	KØ
132-08-048	51	35	-	30	224	13	50	39.5	8	15	164



Plastic Fan
suitable for
NGEF 100 frame
size (3 HP)

No. 1049

DRG. NO.	AØ	BØ	B1	C	DØ	E	H	I	JØ	NO OF BLADES	KØ
100-10-049	45	28	19	20	181	15	35	14	4	12	139

Plastic Fan
suitable for
Beacon 112 frame
size (5 HP)

No. 1050

DRG. NO.	AØ	BØ	B1	C	DØ	E	H	I	JØ	NO OF BLADES	KØ
112-10-050	38	25	-	29.5	193	10	43	22.5	4	12	147

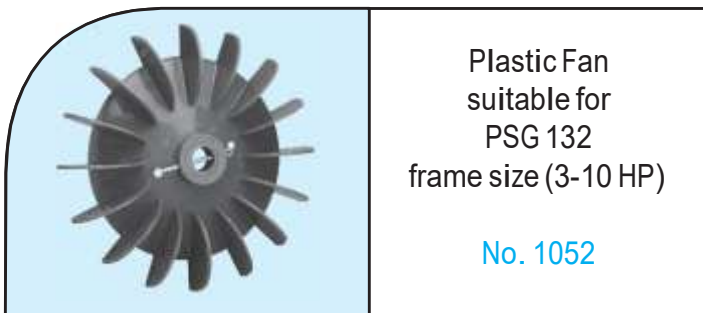

Plastic Fan
suitable for
PSG 132
frame size (3-10 HP)

No. 1052

DRG. NO.	AØ	BØ	B1	C	DØ	E	H	I	JØ	NO OF BLADES	KØ
132-10-052	43	20	28, 30	20	230	18.5	44	12	4	16	176

Plastic Fan
suitable for
90 frame size
(2 HP) (New Type)

No. 1053

DRG. NO.	AØ	BØ	B1	C	DØ	E	H	I	JØ	NO OF BLADES	KØ
90-08-053	26	16	-	18	161	5.5	28	11.5	3	12	128



Plastic Fan
suitable for
Rotor Fan OD 190

No. 1054

DRG. NO.	AØ	BØ	B1	C	DØ	H	I	JØ	NO OF BLADES
RF-02-054	45	35	-	29.5	190	31	7.5	4	15

Plastic Fan
suitable for
71 frame size
(1/2 HP) (New Type)

No. 1055

DRG. NO.	AØ	BØ	B1	C	DØ	E	H	I	JØ	NO OF BLADES	KØ
71-03-055	25	14	15	17	119	8.5	28	13.5	3	10	90

Plastic Fans

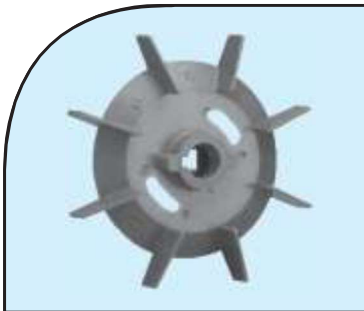

Plastic Fan
suitable for
Texmo 112 frame
size (3-5 HP)

No. 1056

DRG. NO.	AØ	BØ	B1	C	DØ	E	H	G	M	I	J	NO OF BLADES	KØ
112-11-056	44	28	24,25,30 31.5,32	24	216	12	43.5	32	7	12	3/16 BSW	8	160

Plastic Fan
suitable for
Texmo 132
frame size (7.5-10 HP)

No. 1057

DRG. NO.	AØ	BØ	B1	C	DØ	E	H	G	M	I	J	NO OF BLADES	KØ
132-11-057	51	38	35,28	29	263	11	51	40	7.5	25	5/16	12	211

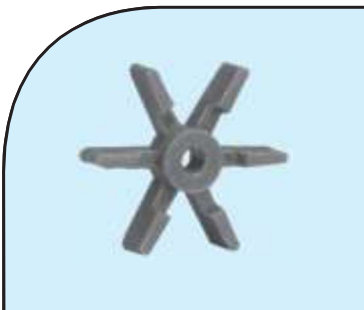

Plastic Fan
suitable for
Coolant Pump Fan

No. 1058

DRG. NO.	AØ	BØ	C	DØ	H	NO OF BLADES
CP-01-058	21.5	9	13.5	73	14	6

Plastic Fan
suitable for
Worthington Simpson
Fan

No. 1059

DRG. NO.	AØ	BØ	B1	C	DØ	H	G	J	NO OF BLADES
RF-03-059	55	32	-	33	138	25	35	7	8

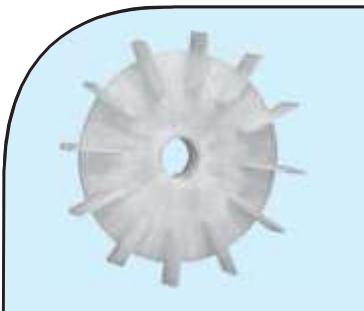

Plastic Fan
suitable for
Jet Pump (GRP)

No. 1060

DRG. NO.	AØ	BØ	B1	C	DØ	H	NO OF BLADES	J	KØ
JP-01-060	35	26	20	17	136	18.5	12	2 BA	114

Plastic Fan
suitable for
Saga Windel
100 frame size (3 HP)

No. 1061

DRG. NO.	AØ	BØ	B1	C	DØ	E	H	I	JØ	NO OF BLADES	KØ
100-11-061	35	19	16	24	177	6	37	15	4	10	134

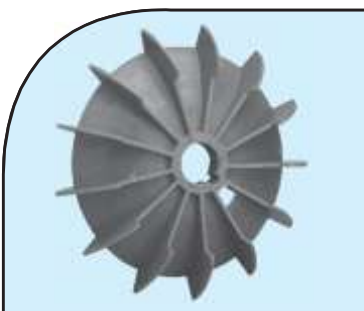

Plastic Fan
suitable for
NGEF 112 frame
size (5 HP)

No. 1062

DRG. NO.	AØ	BØ	B1	C	DØ	E	H	G	M	NO OF BLADES	KØ
112-12-062	44	30	-	17	206	18	45	34	8	13	170

Plastic Fan
suitable for
Texmo 90 frame
size (2 HP)

No. 1063

DRG. NO.	AØ	BØ	B1	C	DØ	E	H	I	JØ	NO OF BLADES	KØ
90-09-063	34	16	-	20	167	5.5	30	15	4	10	136

Plastic Fans

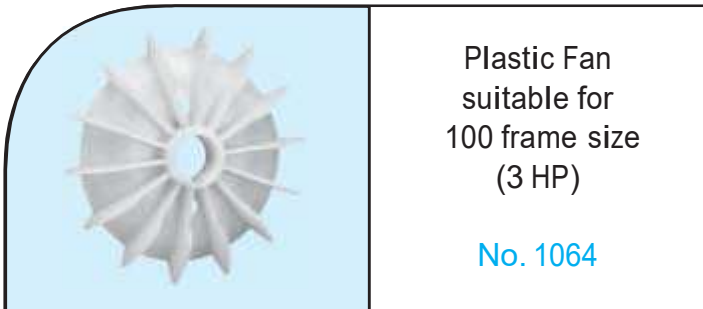

Plastic Fan
suitable for
100 frame size
(3 HP)

No. 1064

DRG. NO.	AØ	BØ	B1	C	DØ	E	H	G	M	NO OF BLADES	KØ
100-12-064	41.5	28	19	24	172	5.5	35	31	7	14	145

Plastic Fan
suitable for
Crompton Jet Pump

No. 1065

DRG. NO.	AØ	BØ	B1	C	DØ	H	I	J	NO OF BLADES
JP-02-065	23	16	-	23	160	19	19	5	10

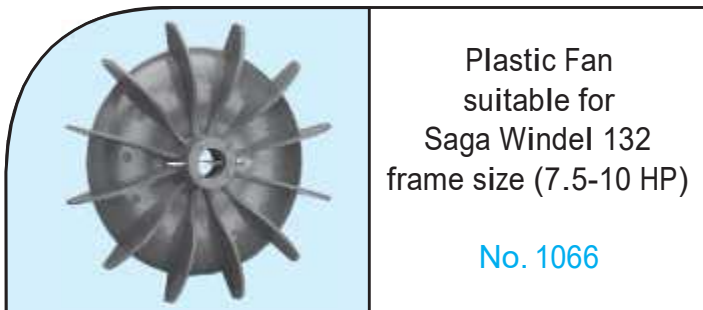

Plastic Fan
suitable for
Saga Windel 132
frame size (7.5-10 HP)

No. 1066

DRG. NO.	AØ	BØ	B1	C	DØ	E	H	I	J	NO OF BLADES	KØ
132-12-066	43.5	24	25	32	242	6	43	20	4	12	195

Plastic Fan
suitable for
Crompton
90 DCB-12

No. 1067

DRG. NO.	AØ	BØ	B1	C	DØ	E	H	I	J	NO OF BLADES	KØ
90-10-067	28	16	-	21	149	6	34.5	13	4	12	115

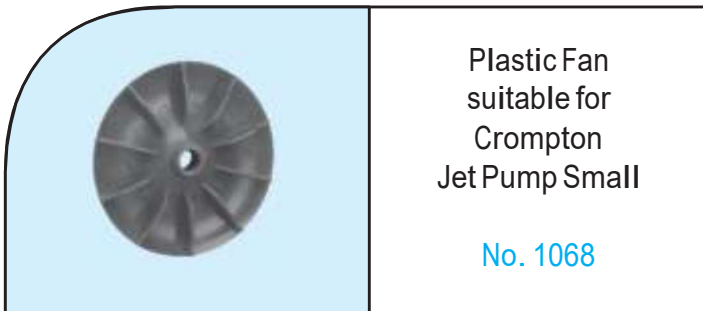

Plastic Fan
suitable for
Crompton
Jet Pump Small

No. 1068

DRG. NO.	AØ	BØ	B1	C	DØ	H	I	J	NO OF BLADES
JP-03-068	24	16	-	24	140	18	18	4	10

Plastic Fan suitable for
Crompton NC-100
frame size (3 HP)
(Double side blades)

No. 1069

DRG. NO.	AØ	BØ	B1	C	DØ	H	I	J	NO OF BLADES
110-13-069	34	28	-	40	178	51	29	5	10

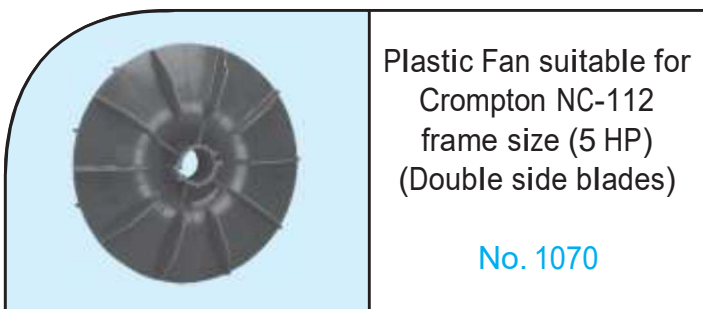

Plastic Fan suitable for
Crompton NC-112
frame size (5 HP)
(Double side blades)

No. 1070

DRG. NO.	AØ	BØ	B1	C	DØ	H	I	J	NO OF BLADES
112-13-070	34	28	-	40	202	52	29	5	10

Plastic Fan suitable for
Crompton NC-132
frame size (7.5-10 HP)
(Double side blades)

No. 1071

DRG. NO.	AØ	BØ	B1	C	DØ	H	I	J	NO OF BLADES
132-13-071	47	38	-	41.5	240	52	29.5	5	12

Plastic Fans

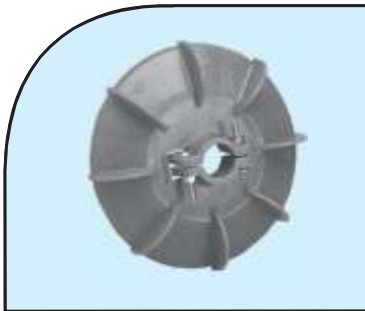

Plastic Fan suitable for Crompton 90 frame size (2 HP)

No. 1072

DRG. NO.	AØ	BØ	B1	C	DØ	E	H	NO OF BLADES	KØ
90-11-072	31	24	-	26	156	13.5	31.5	8	151

Plastic Fan suitable for Crompton 100 frame size (3 HP)

No. 1073

DRG. NO.	AØ	BØ	B1	C	DØ	E	H	NO OF BLADES	KØ
100-14-073	37	28	-	25	180	11	35.5	8	165

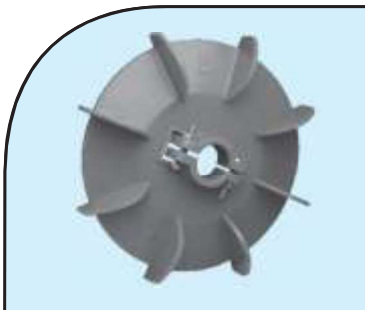

Plastic Fan suitable for Crompton 112 frame size (5 HP)

No. 1074

DRG. NO.	AØ	BØ	B1	C	DØ	E	H	NO OF BLADES	KØ
112-14-074	36.5	28	-	25	204	13	41	8	182

Plastic Fan suitable for Crompton 132 frame size (7.5-10 HP)

No. 1075

DRG. NO.	AØ	BØ	B1	C	DØ	E	H	NO OF BLADES	KØ
132-14-075	49	38	-	29	238	18	52	8	217

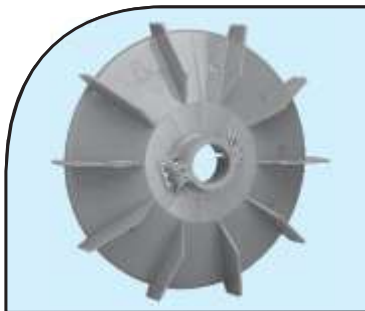

Plastic Fan suitable for Crompton 160 frame size (15-20 HP)

No. 1076

DRG. NO.	AØ	BØ	B1	C	DØ	E	H	NO OF BLADES	KØ
160-05-076	53	42	-	36.5	287	20.5	59	10	261

Plastic Fan suitable for Brown Boverly 100 frame size (3 HP)

No. 1077

DRG. NO.	AØ	BØ	B1	C	DØ	E	F	H	NO OF BLADES	KØ
100-15-077	45	28	-	26.5	174	-	26.5	35.5	7	124



Plastic Fan suitable for Brown Boverly 112 frame size (5 HP)

No. 1078

DRG. NO.	AØ	BØ	B1	C	DØ	E	F	H	NO OF BLADES	KØ
112-15-078	42	28	-	27	192	-	26	41	7	139

Plastic Fan suitable for Brown Boverly 132 frame size (7.5-10 HP)

No. 1079

DRG. NO.	AØ	BØ	B1	C	DØ	E	F	H	NO OF BLADES	KØ
132-15-079	53	32.5	-	26	225	4	30	49.5	7	164

Plastic Fans

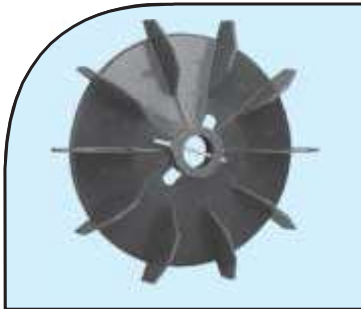

Plastic Fan suitable for Manju 132 frame size (3-10 HP)

No. 1080

DRG. NO.	AØ	BØ	B1	C	DØ	E	H	I	JØ	NO OF BLADES	KØ
132-16-080	43	28	22	21	239	16	53	15	4	10	205

Plastic Fan suitable for C.R.I 132 frame size (3-10 HP)

No. 1081

DRG. NO.	AØ	BØ	B1	C	DØ	E	H	F	I	JØ	NO OF BLADES	KØ
132-17-081	39	21.5	25,28	22	228	11	54	19.5	13	3/16"	8	180



Plastic Fan suitable for Lubi 100 frame size (3 HP)

No. 1082

DRG. NO.	AØ	BØ	B1	C	DØ	E	H	NO OF BLADES	KØ
100-16-082	38	28	-	24	197	18	50	12	157

Plastic Fan suitable for Lubi 112 frame size (5 HP)

No. 1083

DRG. NO.	AØ	BØ	B1	C	DØ	E	H	NO OF BLADES	KØ
112-16-083	44	31	-	16.5	222	22	52.5	14	163.5



Plastic Fan suitable for Suguna 132 frame size (3-5 HP)

No. 1084

DRG. NO.	AØ	BØ	B1	C	DØ	E	H	NO OF BLADES	KØ
132-18-084	42.5	25	-	19	244	19	43	9	126

Plastic Fan suitable for VOTA 112 frame size (3-5 HP)

No. 1085

DRG. NO.	AØ	BØ	B1	C	DØ	E	H	F	NO OF BLADES	KØ
112-17-085	40	22	25	20	216	6	48.5	20	8	169



Plastic Box suitable for Kirloskar 3 HP

No. 1086

DRG. NO.	L	B	H	DØ	CTC
TB-01-086	71	71	42	6.5	50

65 x 49 Plastic Box

No. 1087

DRG. NO.	L	B	H	DØ	CTC
TB-02-087	64	49	22	6	52

Plastic Fans



5 Blade Fan

No. 1088

DRG. NO.	AØ	BØ	B1	C	DØ	E	H	NO OF BLADES
SPF-01-088	23	14	-	18.5	117	6.5	38.5	5

Sharp Pump Fan

No. 1089

DRG. NO.	AØ	BØ	B1	C	DØ	E	H	NO OF BLADES
SPF-02-089	18	15	-	15	125	7	23	4



Plastic Fan suitable for Kirloskar KH-80 frame size (1 HP)

No. 1092

DRG. NO.	AØ	BØ	B1	C	DØ	E	H	I	JØ	NO OF BLADES	KØ
80-05-092	27	19	14,15	16.5	144	7	27	11	4	8	128

Plastic Fan suitable for Kirloskar KH-71 frame size (½ HP)

No. 1093

DRG. NO.	AØ	BØ	B1	C	DØ	E	H	I	JØ	NO OF BLADES	KØ
71-04-093	23.5	15	10,12	14	118	3.5	19.5	6	3	8	101

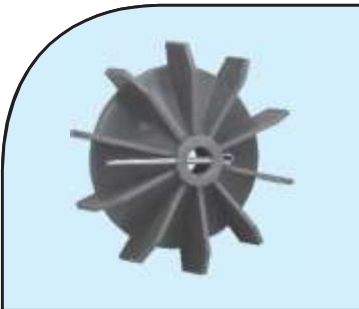

Plastic Fan suitable for Tullu Type

No. 1094

DRG. NO.	AØ	BØ	B1	C	DØ	E	H	I	JØ	NO OF BLADES	KØ
SPF-03-094	19	11	-	16	92	7	24	12	3	10	73

Plastic Fan suitable for Mahendra Type (5-10 HP)

No. 1095

DRG. NO.	AØ	BØ	B1	C	DØ	E	H	I	JØ	NO OF BLADES	KØ
112-18-095	50	22	-	25	215	6	36	15	4	12	170

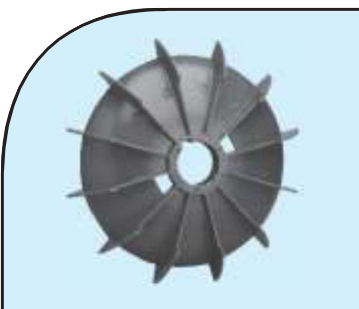

Plastic Fan suitable for NGEF 132 frame size (7.5-10 HP)

No. 1096

DRG. NO.	AØ	BØ	B1	C	DØ	E	H	G	M	NO OF BLADES	KØ
132-19-096	55.5	40	-	22	235	22	52	44	10	12	201

Plastic Fan suitable for Kirloskar KH-63 frame size (1/4 HP)

No. 1097

DRG. NO.	AØ	BØ	B1	C	DØ	E	H	I	JØ	NO OF BLADES	KØ
63-02-097	20.5	12	-	12	105	4.5	20	6	3	8	91

Plastic Fans

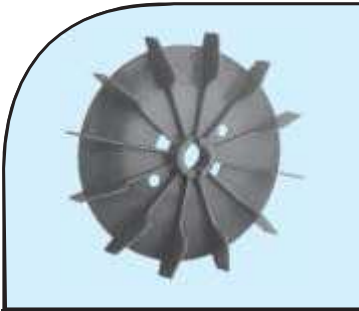

Plastic Fan
suitable for
112 frame size

No. 1098

DRG. NO.	AØ	BØ	B1	C	DØ	E	H	I	JØ	NO OF BLADES	KØ
112-17-098	32	22	-	25	200	8	42	17	6	12	175

Plastic Fan
suitable for Kirloskar
KH/LD-180 frame size
(30-40 HP)

No. 1099

DRG. NO.	AØ	BØ	B1	C	DØ	E	H	JØ	NO OF BLADES	KØ	PCD
180-03-099	100	63	-	6	323	19	62	7	16	265	81

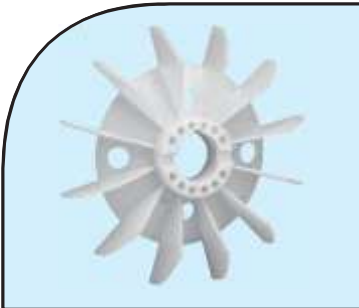

Plastic Fan
suitable for Beacon
132 frame size (7.5-10
HP) (GRP)

No. 1100

DRG. NO.	AØ	BØ	B1	C	DØ	E	H	M	G	J	NO OF BLADES	KØ
132-20-100	70	42	-	28	234	7	46	9	45	9	12	161

Plastic Fan
suitable for
90 frame size

No. 1101

DRG. NO.	AØ	BØ	C	DØ	E	H	NO OF BLADES	KØ
90-12-101	43	30	25	160	2	29	10	120

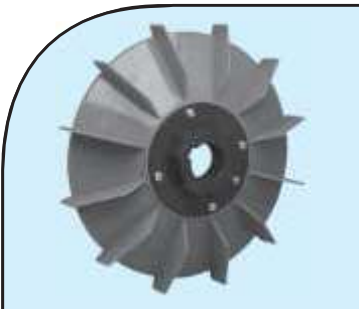

Plastic Fan
suitable for
180 frame size
(30-40 HP)

No. 1102

DRG. NO.	AØ	BØ	B1	C	DØ	E	H	J	M	I	KØ	NO OF BLADES
180-04-102	75	45	48,50 55,60	35	330	26	62	6mm Taping	13	25	300	12

Plastic Fan
suitable for
Bharat Bijlee 90
frame size (2 HP)

No. 1103

DRG. NO.	AØ	BØ	C	DØ	E	H	M	N	NO OF BLADES	KØ
90-13-103	38	24.6	18.9	150	19.6	37	7.8	22	7	125

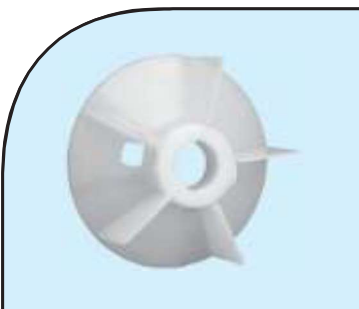

Plastic Fan
suitable for
Bharat Bijlee 160
frame size 2 Pole

No. 1104

DRG. NO.	AØ	BØ	B1	C	DØ	E	H	M	G	NO OF BLADES
160-06-104	77.4	45	-	35	202	29	76	7.8	54	5

Plastic Fan
suitable for
Bharat Bijlee 180
frame size 2 Pole

No. 1105

DRG. NO.	AØ	BØ	B1	C	DØ	E	H	M	N	NO OF BLADES
180-05-105	77.4	49	-	40	202	29	79	14	43.5	5

Plastic Fans

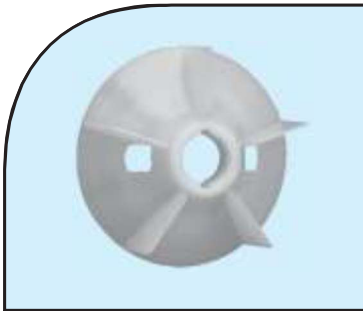

Plastic Fan suitable for Bharat Bijlee 132 frame size 2 Pole

No. 1106

DRG. NO.	AØ	BØ	B1	C	DØ	E	H	M	G	NO OF BLADES
132-21-106	65	40	-	27	186.5	28	68	7.8	49	5

Plastic Fan suitable for Bharat Bijlee 80 frame size (1 HP)

No. 1107

DRG. NO.	AØ	BØ	C	DØ	E	H	I	JØ	NO OF BLADES	KØ
80-06-107	35	20	15	140	7	24	13	2.7	12	106

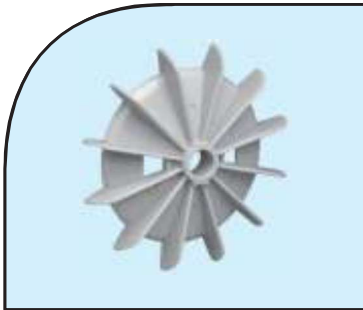

Plastic Fan suitable for Bharat Bijlee 71 frame size (½ HP)

No. 1108

DRG. NO.	AØ	BØ	C	DØ	E	H	I	J	NO OF BLADES	KØ
71-05-108	21	15	16	127	5	21	12	3.5	12	98

Plastic Fan suitable for Bharat Bijlee 180 frame size (30-40 HP)

No. 1109

DRG. NO.	AØ	BØ	C	DØ	E	H	M	N	NO OF BLADES
180-06-109	77.4	49	40	225	32	82	14	43.5	5

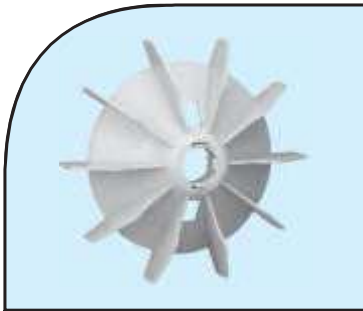

Plastic Fan suitable for Bharat Bijlee 100 frame size (3 HP)

No. 1110

DRG. NO.	AØ	BØ	C	DØ	E	H	M	N	NO OF BLADES	KØ
100-17-110	40	25	17.5	171	20	39	7.8	22	10	131

Plastic Fan suitable for Bharat Bijlee 112 frame size (5 HP)

No. 1111

DRG. NO.	AØ	BØ	C	DØ	E	H	M	N	NO OF BLADES	KØ
112-20-111	55	25	25	197	19	44.5	7.8	22	10	151

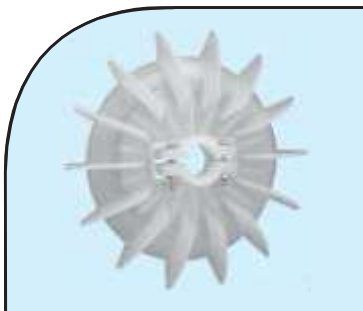

Plastic Fan suitable for KO 132 frame size

No. 1112

DRG. NO.	AØ	BØ	B1	C	DØ	E	H	NO OF BLADES	KØ
132-23-112	44	29	32,33	29	232	13	50	14	182

Plastic Fan suitable for ABB 160 frame size 4 Pole

No. 1113

DRG. NO.	AØ	BØ	C	DØ	E	H	M	N	NO OF BLADES	KØ
160-07-113	50	38	35.5	282	16.5	57.5	10	33.3	9	205

Plastic Fans

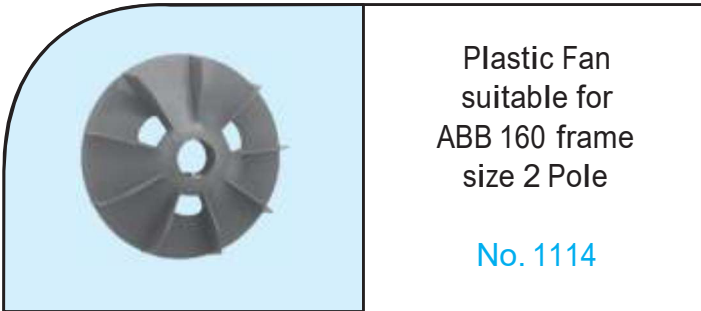

Plastic Fan
suitable for
ABB 160 frame
size 2 Pole

No. 1114

DRG. NO.	AØ	BØ	C	DØ	E	H	M	N	NO OF BLADES	KØ
160-08-114	50	38	35.5	207	16.5	57.5	10	33.3	9	205

Plastic Fan
suitable for
DK-7

No. 1115

DRG. NO.	A	B	B1	C	D	E	H	M	N	NO OF BLADES	KØ
1115	28	14	-	20	130	8	31.5	5	16	12	103

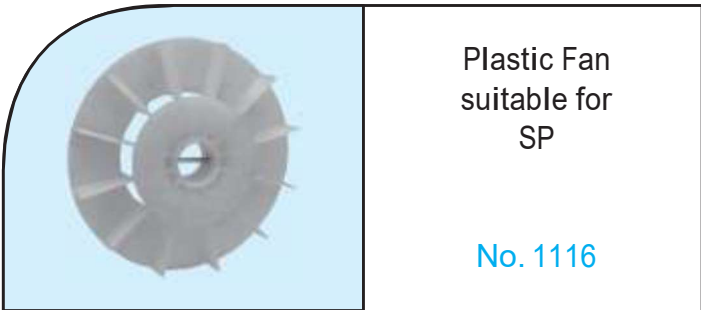

Plastic Fan
suitable for
SP

No. 1116

DRG. NO.	AØ	BØ	C	DØ	E	H	J	NO OF BLADES
1116	28	22	21	136	-	24	3	12

Plastic Fan
suitable for
Kirloskar 63 frame
size (1/4 HP)

No. 1117

DRG. NO.	AØ	BØ	C	DØ	E	H	I	JØ	NO OF BLADES	KØ
63-03-117	23	10	11.5	91	1.25	18.5	10	3	12	78



Plastic Fan
suitable for
Kirloskar 71 frame
size (1/2 HP)

No. 1118

DRG. NO.	AØ	BØ	C	DØ	E	H	J	NO OF BLADES	KØ
71-06-118	24	14.5	12	122	4	20	3	8	102

Plastic Fan
suitable for
Alstom 180/200 frame
size (30-40 HP)

No. 1119

DRG. NO.	AØ	BØ	C	DØ	E	H	I	J	NO OF BLADES	KØ
180/200-07 119	54	43	40	274	2.5	54	30	5	14	212



Plastic Fan
suitable for Bharat
Bijlee 200/225 frame
size 2 Pole

No. 1120

DRG. NO.	AØ	BØ	C	DØ	E	H	M	N	NO OF BLADES
200/225 -01-120	92	57.6	45	264	17	110	14	52.5	5

Plastic Fan
suitable for
Bharat Bijlee
200 frame size 4 pole

No. 1121

DRG. NO.	A	B	C	D	E	H	M	N	NO OF BLADES
200-02-121	92	57.6	45	282	16	85	14	52.5	5

Plastic Fans

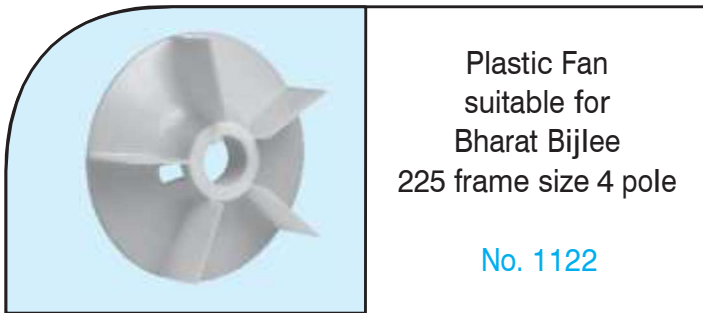

Plastic Fan
suitable for
Bharat Bijlee
225 frame size 4 pole

No. 1122

DRG. NO.	A	B	C	D	E	H	M	N	NO OF BLADES
225-01-122	92	57.6	45	302	16	95	14	52.5	5

Plastic Fan
suitable for
DK-6

No. 1123

DRG. NO.	A	B	B1	C	D	E	H	M	N	NO OF BLADES	KØ
1123	27	14	11	18.5	115	7.5	28	5	16	12	90

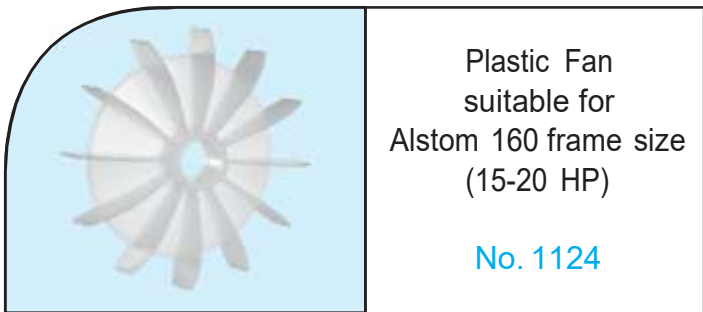

Plastic Fan
suitable for
Alstom 160 frame size
(15-20 HP)

No. 1124

DRG. NO.	A	B	C	D	E	H	I	J	NO OF BLADES	KØ
160-09-124	57	43	40	254	2	55	30	5	12	200

Plastic Fan
suitable for Kirloskar Y
Series KI-112
frame size (5 HP)

No. 1125

DRG. NO.	A	B	C	D	E	H	M	N	NO OF BLADES	KØ
112-21-125	35	28	29.5	155	7.5	35	8	24	6	120

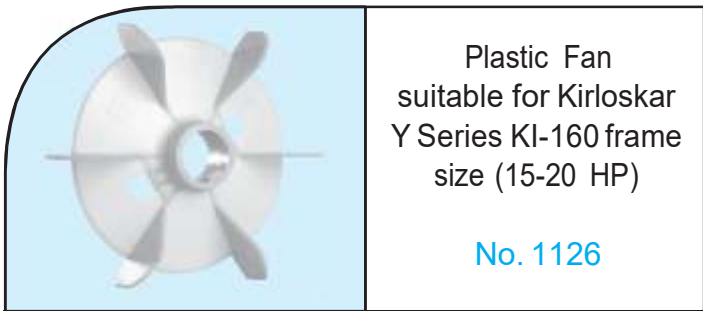

Plastic Fan
suitable for Kirloskar
Y Series KI-160 frame
size (15-20 HP)

No. 1126

DRG. NO.	A	B	C	D	E	H	M	N	NO OF BLADES	KØ
160-10-126	54.5	43	40	248	8	59	12	38	6	200

Plastic Fan
suitable for E-132
frame size (7.5-10 HP)

No. 1127

DRG. NO.	A	B	B1	C	D	E	H	NO OF BLADES	KØ
132-24-127	48	38	32,35 42	30	238	11	48	12	103

Plastic Fans

Plastic Fans for Alternators

No. 1196

DRG. NO.	A	B	C	D	E	H	NO OF BLADES	K
1196	60.5	48.2	26.5	232.5	16.5	50.3	11	204.5

Plastic Fans for Alternators

No. 1197

DRG. NO.	A	B	C	D	E	H	NO OF BLADES	K
1197	100	66	42	239.5	37	40	12	165

450 mm Carriage Fan

No. 1198

400 mm Carriage Fan

No. 1199